

# Duro User Manual

## Version 2.0



# Table of Contents

<b>Notice to Users</b>	<b>4</b>
Antenna Placement Guidelines	6
<b>Limited Warranty Terms and Conditions</b>	<b>7</b>
<b>Product Introduction</b>	<b>8</b>
Overview	8
Why Duro?	8
<b>Technical Information</b>	<b>9</b>
Physical and Environmental	9
Enclosure	9
Connectors	
Power Connector	13
Evaluation Kit Power Cable Description	14
Ethernet Connector	15
Serial Connector	17
AUX Connector	19
GNSS Antenna Connector	22
Standards and Certifications	23
Environmental Testing	24
Shock	24
Vibration	24
Temperature	24
Ingress and IP67	24
EMI/EMC	24
Mounting Duro Antenna	25
With Top-Mounted GNSS Antenna	25
Attach Antenna to Bracket	28
Connect Antenna to Duro	29
Large GNSS Antenna Cable	29

Grounding Duro	29
Power	30
Interfaces	31
LED Indicators	31
Serial Ports	32
GNSS Tracking	32
Accuracy	33
<b>Connecting to Duro</b>	<b>34</b>
Ethernet Connection	34
Swift Console	34
Serial Connection	38
<b>Firmware Upgrades</b>	<b>39</b>
Swift Console	39
<b>Swift Navigation Technical Support</b>	<b>41</b>
Support Site	41
Supporting Tools	41
Contact Us	41

## Notice to Users

### Industry United States Statement

#### FCC Statement

This device complies with Part 15 of the FCC Rules. Operation is subject to the following two conditions: (1) This device may not cause harmful interference and (2) this device must accept any interference received, including interference that may cause undesired operation.

Maximum antenna gain is limited to 5.29 dBi for the GSM 850 frequency band, 4.02 dBi for the PCS 1900 frequency band and 6.32 dBi for the FDD IV frequency band.

### Industry Canada Statement

#### Industry Canada Compliance

This Class B digital apparatus complies with Canadian ICES-003. Operation is subject to the following two conditions:

- (1) This device may not cause interference.
- (2) This device must accept any interference, including interference that may cause undesired operation of the device.

#### **Conformité d'Industrie Canada**

*Cet appareil numérique de la classe B est conforme à la norme NMB-003 du Canada. L'exploitation est autorisée aux deux conditions suivantes*

- (1) l'appareil ne doit pas produire de brouillage*
- (2) l'appareil doit accepter tout brouillage radioélectrique subi, même si le brouillage est susceptible d'en compromettre le fonctionnement.*

User instructions/antenna/etc.—see FCC section above.

### Industry European Union Statement

Swift Navigation hereby declares that Duro is in compliance with the essential requirements and other relevant provisions of the 2014/30/EU Directive and UN/ECE Regulation 10.

Duro is compliant with the European Community Restriction of Hazardous Substances Directive 2002/95/EC, (RoHS 1) and the Directive 2012/19/EU on waste electrical and electronic equipment (WEEE) and is marked with the WEEE symbol and RoHS logo.

The symbol on the product or its packaging indicates that this product must not be disposed of with other household or office waste. Instead, it is the owner's responsibility to dispose of Duro waste equipment by handing it over to a designated collection point for the recycling of waste electrical and electronic equipment. The separate collection and recycling of waste equipment at the time of disposal will help conserve natural resources and ensure that it is recycled in a manner that protects human health and the environment. For more information about locations where Duro waste can be

dropped off for recycling, please contact your local authority.

## California Proposition 65

**WARNING:** This product contains a chemical known to the state of California to cause cancer.

## Japan

この装置は、クラスB 情報技術装置です。この装置は、家庭環境で使用することを目的としていますが、この装置がラジオやテレビジョン受信機に近接して使用されると、受信障害を引き起こすことがあります。

取扱説明書に従って正しい取り扱いをして下さい。

VCCI-B

## Korea

이 기기는 가정용(B급) 전자파적합기기로서 주로 가정에서 사용하는 것을 목적으로 하며, 모든 지역에서 사용할 수 있습니다.





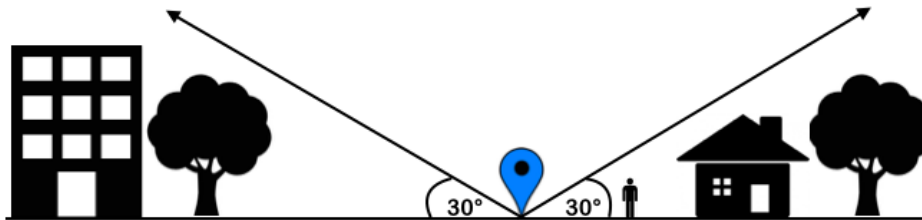

## Antenna Placement Guidelines

Position the antenna as indicated by the blue marker, at a spot with a sky view that is unobstructed above 30 degrees up from the horizon in every direction. For the best results, install the antenna on the top of a tripod (using the included threading adapter) or other stable structure.

Duro's high-precision, multi-band GNSS antenna is sensitive to its environment. Since Duro needs to track carrier phase information from GNSS satellites, it is much more sensitive to obstructions than standard consumer GNSS receivers found in, for example, smartphones. Thus, the Duro antenna must be kept away from *any* obstructions to its sky view.



- Do place the antenna on a tripod.
- Do not test inside a building.
- Do not place the antenna near buildings.
- Do not place the antenna near trees and other cover.
- Do not stand near the antenna or put your hand over the antenna during testing.
- Do not place an open laptop near the antenna so that the laptop itself is blocking the sky view.

		
Not indoor	Not near buildings	Not near trees
		
Not near people	Not near laptop	

## Limited Warranty Terms and Conditions

Please, refer to the Swift Navigation website for information about product warranty information. <https://www.swiftnav.com/warranty-information>. Warranty is voided if Duro back access panel is opened.

# Product Introduction

## Overview

Duro® is a ruggedized version of the Piksi® Multi RTK GNSS receiver. Built to be tough, Duro is ideal for mining, agricultural, robotics, maritime and outdoor industrial applications. Duro is designed for integration into or mounting on top of existing equipment. With its cast aluminum housing, this easy-to-deploy GNSS sensor is protected against weather, moisture, vibration, dust, water immersion and the unexpected that can occur in outdoor long-term deployments.

## Why Duro?

### Centimeter-Level Accuracy

Autonomous devices require precise navigation—especially those that perform critical functions. Swift Navigation's Piksi Multi module within Duro utilizes real-time kinematics (RTK) technology, providing location solutions that are 100 times more accurate than traditional GPS.

### Easy Integration

Duro is easily integrated into your application as its sealed, and industry standard, connectors enable easy deployment in all conditions. The exposed interfaces support varied use cases without integration challenges.

### Leverages Piksi Multi

Multiple signal bands enable fast convergence times and multiple satellite constellations enhance availability. Piksi Multi currently supports GPS L1/L2 with plans to provide GLONASS G1/G2 in 2017. Other constellations such as BeiDou, Galileo and SBAS are planned to be rolled out in the near future. There are no additional upgrade charges for constellation upgrades.

### Features and Benefits

- Dual-frequency RTK GNSS, providing accurate position and solution fast recovery
- Tough, military-grade hardware
- IP67-rated enclosure with M12 standard-sealed connectors
- Raw IMU data stream output
- Future-proof hardware with in-field software upgrades
- Protected I/O, including RS232 Serial Ports, 100Mbit Ethernet, Event Inputs, Pulse Per Second (PPS) and more
- Durable UV and chemical-resistant powder-coating
- Multiple mounting interfaces



# Technical Information

## Physical and Environmental

The following outline provides an overview of the physical and environmental aspects of Duro.

### Enclosure

The Duro ruggedized enclosure offers a series of mounting options, making it flexible to adapt to your mounting requirements:

- Pin Holes/Slots
- ¼-20 Thread Insert
- Threaded Mounting

The following section showcases Duro enclosure measurements. All measurements are in millimeters

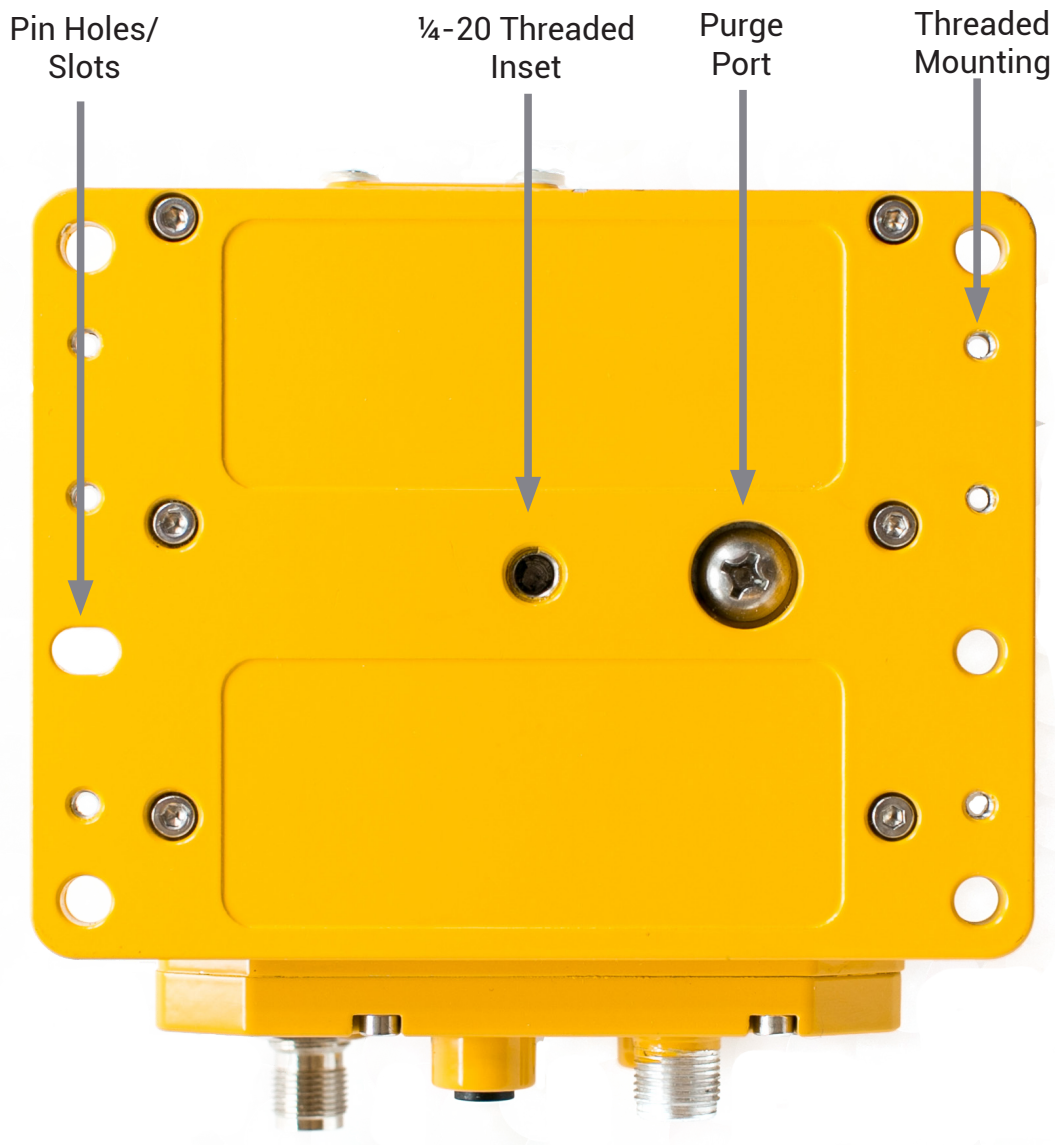

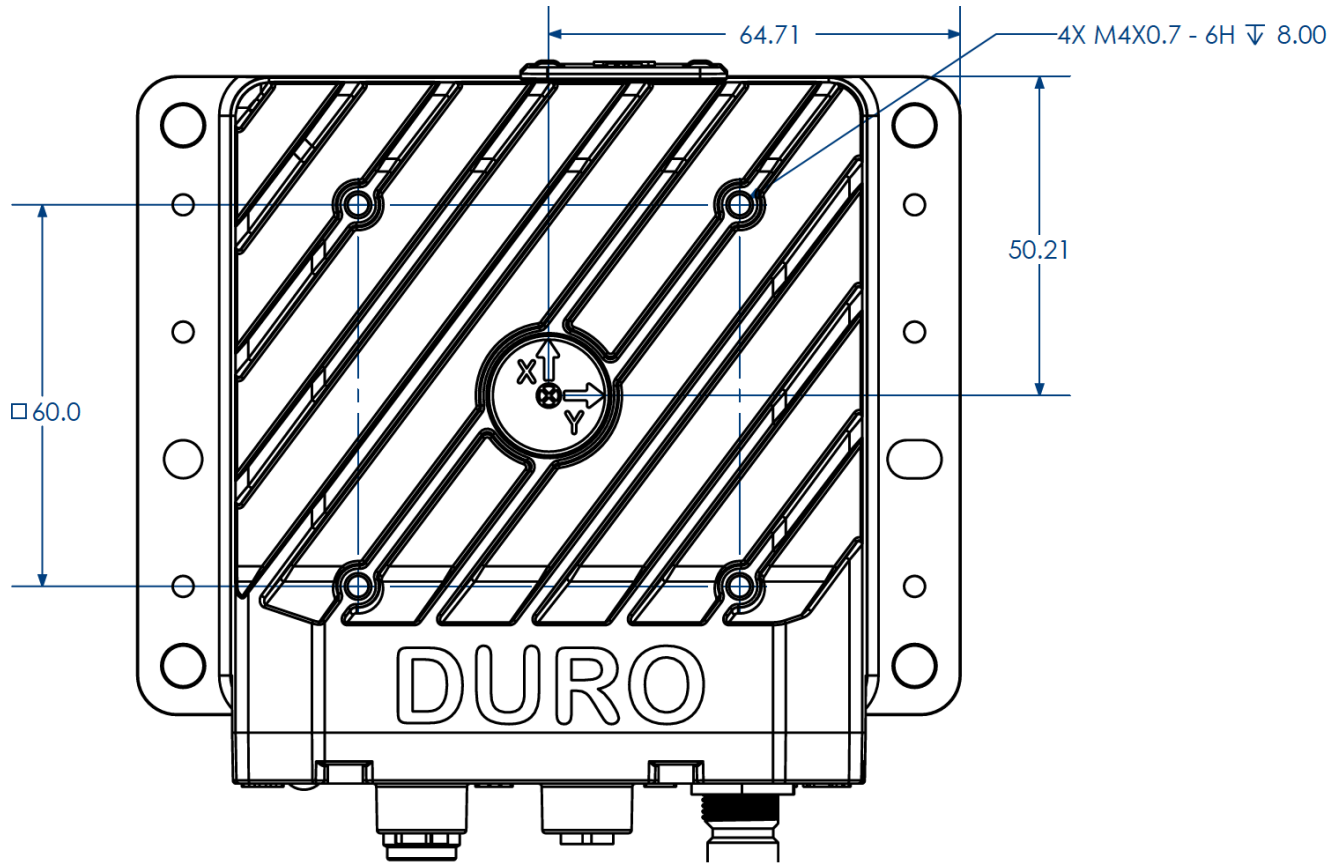

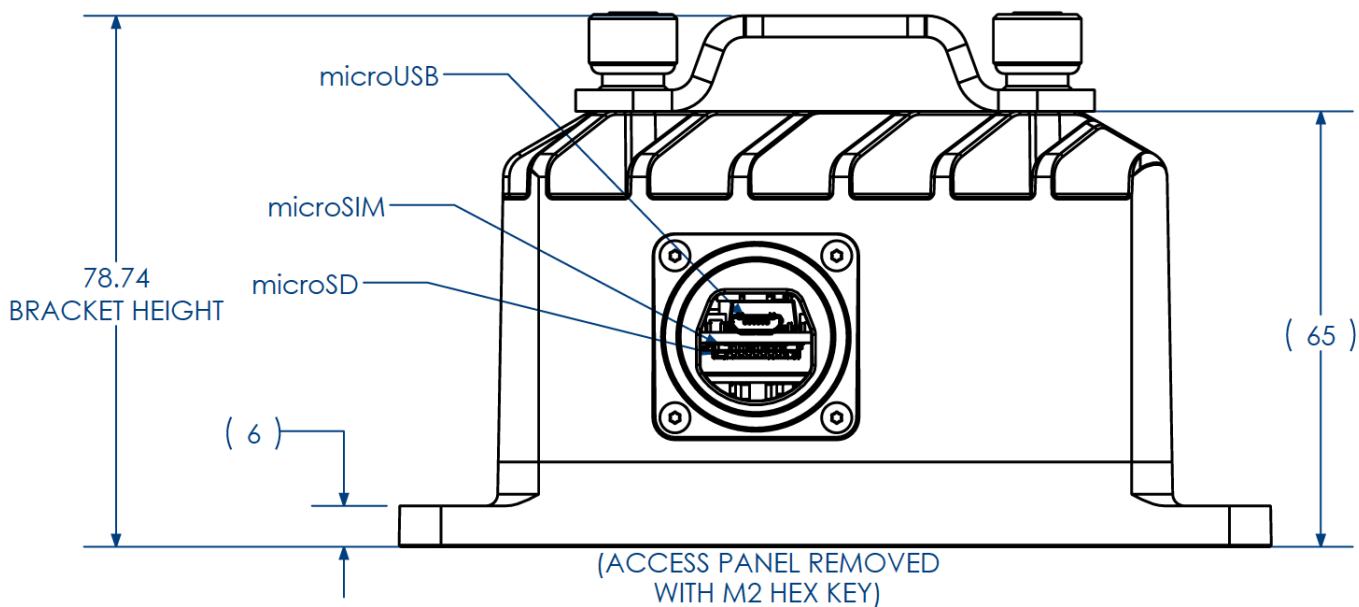
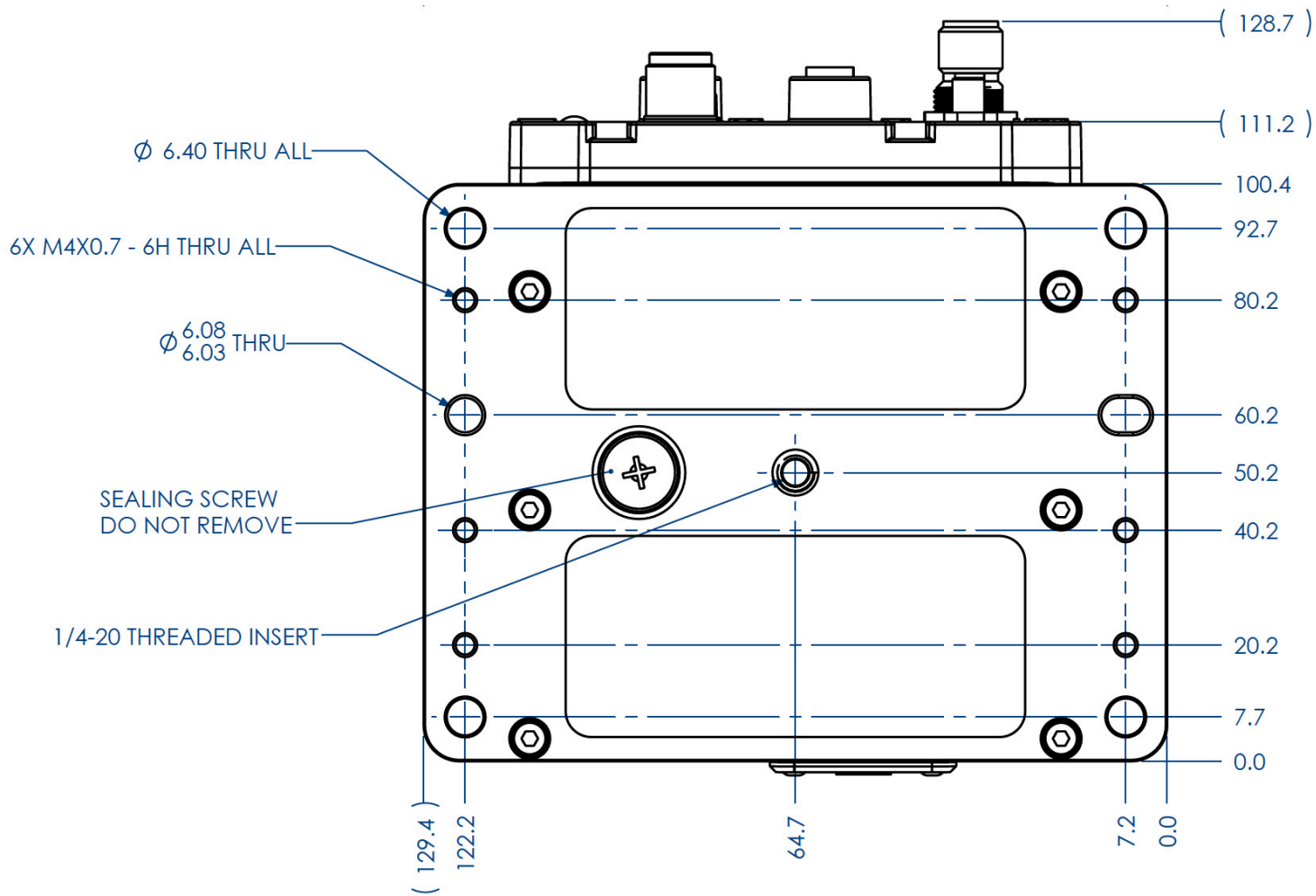

## Connectors

Duro's M12 connectors are sealed and industry standard, which balances ruggedization perfectly with user-friendliness. No external sealing is required to deploy Duro, in even the harshest conditions. Duro has the following connectors:

- Power
- Ethernet
- Serial
- AUX
- GNSS Antenna

The sections that follow explain the signal description for each connector and the cables provided with the Duro Evaluation Kit. Importantly, the connectors or their respective caps need to be mated to provide sealing functionality to meet IP67 standards.

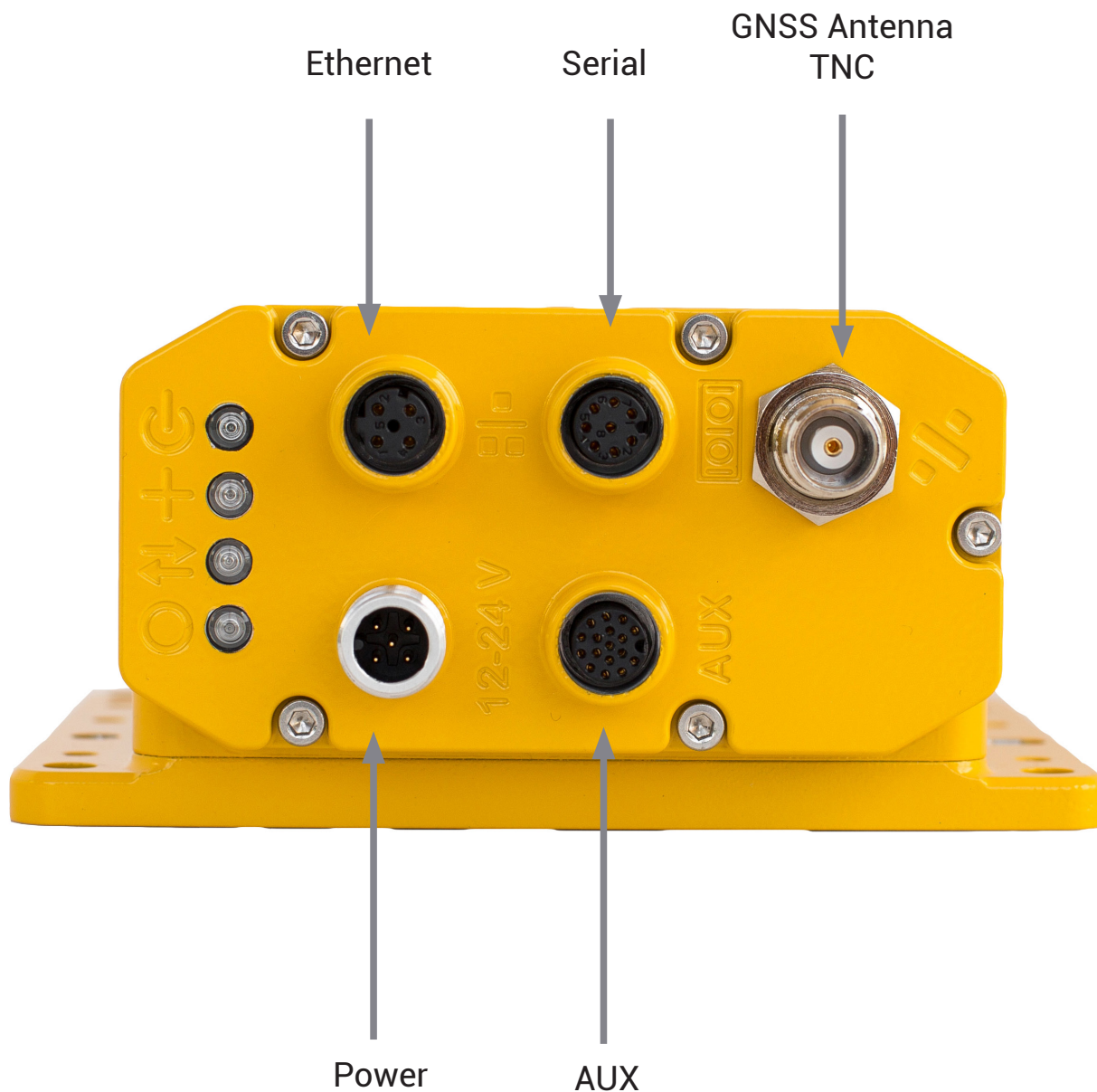

## Power Connector

The power connection provides power input to Duro from a DC source. It also provides a chassis ground pin and digital input and outputs.

M12-A/M: Duro M12 5 Pin Male Connector, A Keying

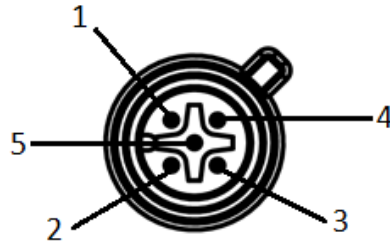

M12 Pin F	Name	Description	Type	Minimum	Typical	Maximum	Units
1	Vin	Voltage Input (Refer Power Section)	Input	12	--	24	V
2	Chassis_GND	Signal Internally Connected to Duro Chassis	--	--	--	--	--
3	GND	Power Ground	GND	--	--	--	--
4	PPS	Pulse Per Second digital signal synchronized with GPS second	Output	--	5	--	N/A
5	EVENT_A	Event Input Signal	Input	3.3	5	Vin	V

Evaluation Kit Power Cable (Part#90-M12A5F\_DCJ-08-X1) Description

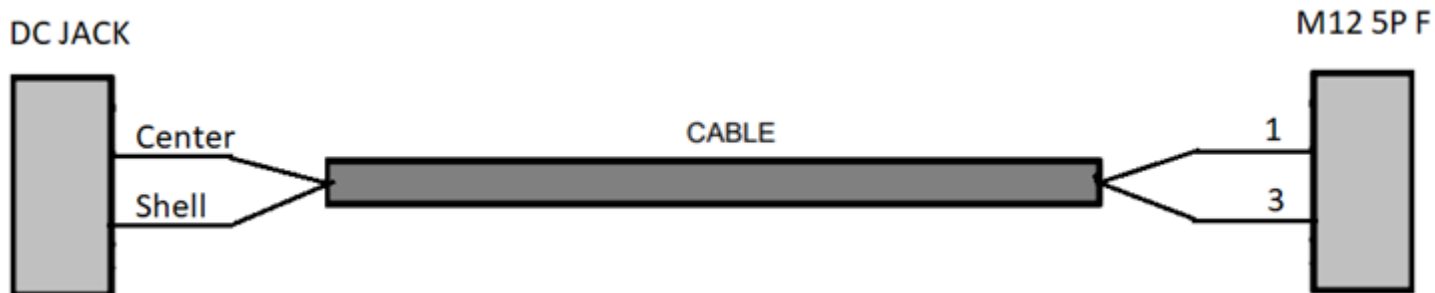

M12 5P (Male)	DC Jack	Name	Type	Color	Description
1	Center	Vin	Input	Black	Voltage Input 12-24V
3	Shell	GND	GND	White	Power Ground

## Ethernet Connector

The Ethernet connector is provided as the de-facto standard for industrial Ethernet with M12 circular connectors. There are many off-the-shelf cables available to mate with this connector. For reference, the mating cable provided with the Duro Evaluation Kit is provided below.

M12-D/F: Duro M12 4P Female Connector, D Keying



M12 Pin F	Name	Description	Type	Minimum	Typical	Maximum	Units
1	TX+	Ethernet Tx+	Output	--	--	2.5	V
2	RX+	Ethernet RX+	Input	--	--	2.5	V
3	TX-	Ethernet TX-	Output	-2.5	--	--	V
4	RX-	Ethernet RX-	Input	-2.5	--	--	V

Ethernet Cable (Part#90-M12D4M/R8-08) Description

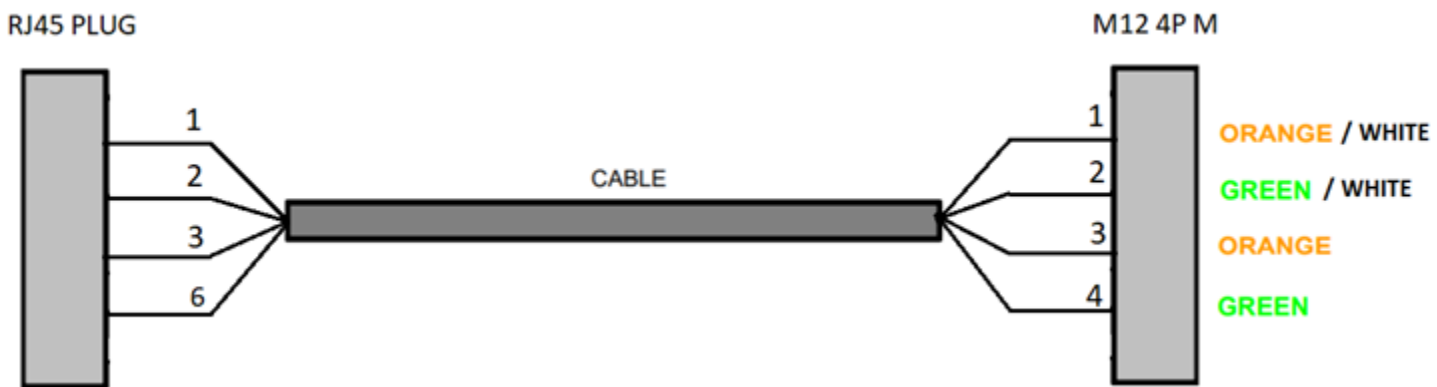

M12 4P (Male)	RJ45 PLUG	Name	Type	Color	Description
1	1	TX+	Output	Orange/ White	Ethernet TX+
2	3	RX+	Input	Green / White	Ethernet RX+
3	2	TX-	Output	Orange	Ethernet TX-
4	6	RX-	Input	Green	Ethernet RX-



## Serial Connector

The serial connection cable is provided to allow serial communication to downstream devices. This connector can also provide 12 volt power output for downstream device such as radio modems. The intention is that one cable mated with this connector can provide power and data communications to a serial modem for some applications. Note, the serial connection on this connector corresponds to UART0 on Piksi Multi, which under default settings is configured to provide only the SBP messages required to use Piksi Multi as a base station.

### Duro M12 8P Female Connector

M12 A code Pin (female)

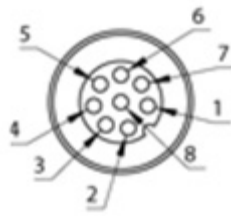

M12 Pin F	Name	Description	Type	Minimum	Typical	Maximum	Units
1	TX	UART0 Transit Asynchronous Data Output	Output	-5	+/-5	5	V
2	RX	UART0 Receive Asynchronous Data Input	Input	-25	+/-5	25	V
3	CTS	UART0 Clear to Send Control Input / Handshake Signal	Input	-25	+/-5	25	V
4	EVENT_C	RESERVED (Future Digital Input)	Input	3.3V	5	V <sub>in</sub>	V
5	GND	Device Ground Supply	GND	--	--	--	--
6	12VOUT	12 Volt Power Output (+- 10% Depending on V <sub>in</sub> )	Output	10.8	12	13.4	V
7	PPS	Pulse Per Second Digital Output	Output	--	V <sub>in</sub>	--	V
8	RTS	UART0 Request to Send Control Output / Handshake Signal	Output	-5	+/-5	5	V

## Serial Cable (Part#90-M12A8M/D9F-06) Description

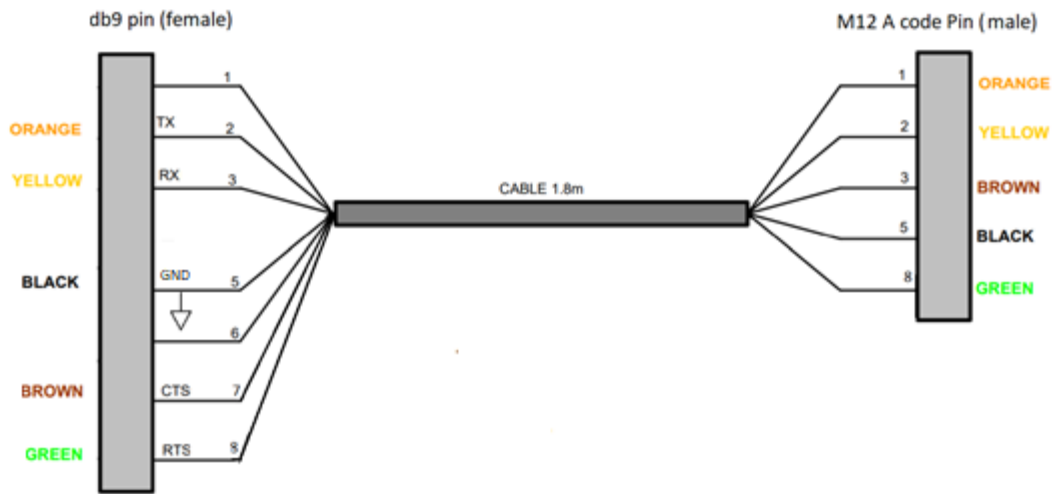

M12 Pin (Male)	Db 9 Pin (Female)	Name	Type	Color	Description
1	2	TX	Output	Orange	Transit Asynchronous Data Output
2	3	RX	Input	Yellow	Receive Asynchronous Data Input
5	5	GND	GND	Black	Device Ground Supply
3	7	CTS	Input	Brown	Clear to Send Control Input / Handshake Signal
8	8	RTS	Output	Green	Request to Send Control Output / Handshake Signal

## AUX Connector

The AUX connection on Duro is intended to be used for more full-featured applications on the device. It provides serial and additional digital inputs and outputs, including those intended for an encoder. It also provides both 12 volt and 5 volt power output for downstream devices. Use the serial port from this connector to establish communication with your computer (UART1).

M12-A/F (Duro M12 17P Female Connector, A Coded)



M12 17P F	Name	Description	Type	Minimum	Typical	Maximum	Units
1	CAN_L	CAN1_L	I/O	0.5	0.9	1.65	V
2	+5V-Out	5 Volt Power Output (0.37A Max)	Output	--	5V	--	V
3	RTS	UART1 Request to Send Control Output / Handshake Signal	Output	-5	+/-5	5	V
4	CTS	UART1 Clear to Send Control Input / Handshake Signal	Input	-25	--	25	V
5	+12V-Out	12 V Power Output at 1 A Max (+- 10% Depending on Vin)	Output	10.8	12V	13.4	V
6	GND	Ground for 12 or 5 V output	Output	--	--	--	--
7	Enc B -	RESERVED (Future Encoder Support)	Input	-7	--	12	VDC
8	Enc A -	RESERVED (Future Encoder Support)	Input	-7	--	12	VDC
9	Enc A +	RESERVED (Future Encoder Support)	Input	-7	--	12	VDC
10	TX	UART1 Transit Asynchronous Data Output	Output	-25	+/-5.5	25	V

11	RX	UART1 Receive Asynchronous Data Input	Input	-25	--	25	V
12	CAN_H	CAN1_H	I/O	2.15	2.9	3.3	V
13	PPS	Pulse Per Second Output	Output	--	Vin	Vin	V
14	GND	Ground for 12 or 5 V output	Output	--	--	--	
15	Enc B +	RESERVED (Future Encoder Support)	Input	-7	--	12	VDC
16	DI / Event B	RESERVED (Future Digital Input)	Input	3.3	5	Vin	
17	DO / PV	Position Valid Digital Output	Output	--	--	Vin	

AUX Cable (Par#90-M12A17/09+15-03) Descriptions

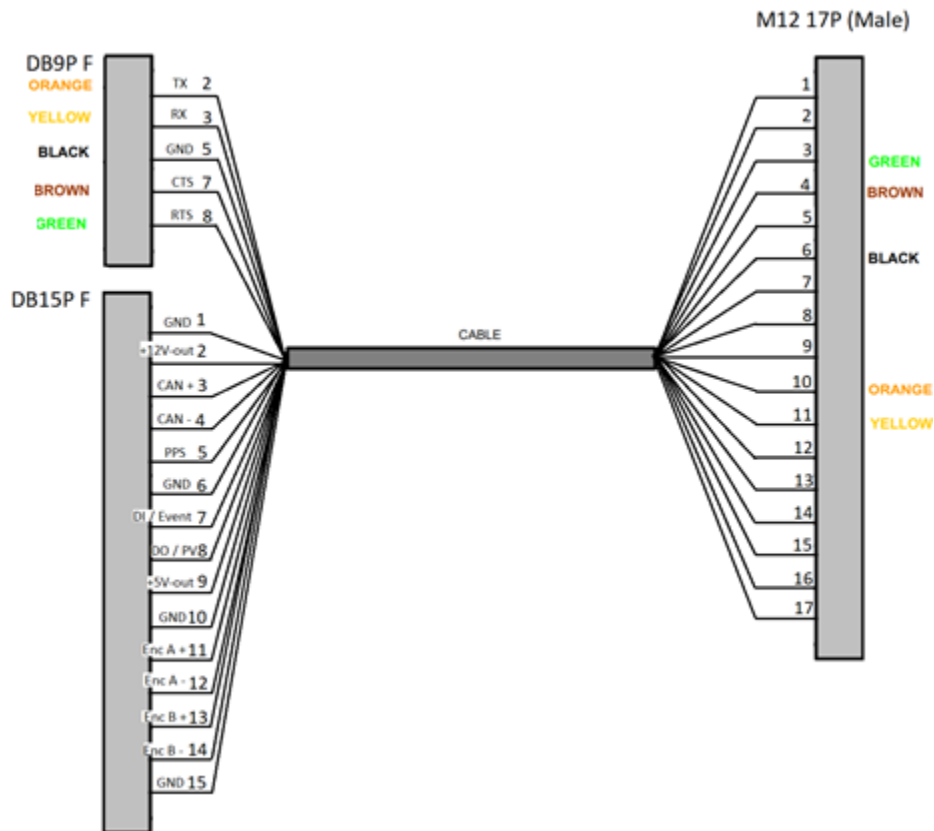

M12 17P M	DB9 F	DB15P F	Name	Type	Color	Description
1		4	CAN_L			CAN1_L
2		9	+5V-Out	Output		5 V Power Output
3	8		RTS	Output	Green	
4	7		CTS	Input	Brown	
5		2	+12V-Out	Output		12 V Power Output
6	5		GND		Black	
7		14	Enc B -	N/A		
8		12	Enc A -	N/A		
9		11	Enc A +	N/A		
10	2		TX	Output	Orange	UART1 Transit Asynchronous Data Output
11	3		RX	Input	Yellow	UART1 Receive Asynchronous Data Input
12		3	CAN +		N/A	CAN_H

13		5	PPS	Output	N/A	Pulse Per Second Output
14		1+6+10+15	GND	GND	N/A	Device Ground Supply
15		13	Enc B +		N/A	N/A
16		7	DI / Event			
17		8	DO / PV			

### GNSS Antenna Connector

A TNC female connection is provided to connect GNSS antennas to Duro. Active antennas are required for Duro operation and the 4.80 volt 100 milliamp maximum current antenna bias is software enabled. Antennas with an LNA gain between 28 dB and 45 dB are recommended.

## Standards and Certifications

Duro and typical cabling have been verified to be compliant with applicable regional standards for radiated emissions:

- IEC 60950-1
- IP67
- FCC Part 15B
- ICES-003
- 2014/30/EU Directive
- UN/ECE Regulation 10
- The European Community Restriction of Hazardous Substances Directive 2002/95/EC, (RoHS 1)
- Directive 2012/19/EU on Waste Electrical and Electronic Equipment (WEEE)
- VCCI-B
- KCC
- *Australia - TBD*
- *New Zealand - TBD*



## Environmental Testing

Duro has been extensively tested by Swift Navigation, Carnegie Robotics and third parties to meet rigorous standards. A brief description of the test regime is below. For more information about testing and test reports, please contact Swift Navigation.

### Shock

Duro has been tested to withstand 40G and 65G shock. Duro was subjected to 3 positive and 3 negative half-sine shock pulses at 40Gs over 15-23 minutes. Duro was subjected to the UUT that included 3 positive and 3 negative shock pulses at 65Gs over 8 minutes. The Duro device survived all shocks to which it was subjected.

### Vibration

To verify vibration testing, Duro was subjected to 7.7 G root mean square (rms) per the MIL-STD-810 Minimum Integrity Test Specification for 60 minutes per axis. The device was also subject to 5 G sinusoidal vibration in a test according to common methods. During the sinusoidal vibration test, Duro was subjected to Sine Sweep Vibration at 5 G Peak from 10 Hz to 2 kHz with a sweep rate of 0.25 oct/min. Duro navigated and operated before, during and after all vibration tests with no faults and little degradation of navigation performance.

### Temperature

Operating temperature ranges have been verified from -40 to +75 degrees centigrade.

### Ingress and IP67

Duro has been verified to meet Ingress Protection (IP) level 67, meaning it is impervious to dust and able to withstand submersion in up to 1 meter of water for 30 minutes.

### EMI/EMC

Duro and typical cabling has been verified to be FCC part 15 compliant with respect to radiated emissions and susceptibility to interference.



## Mounting Duro Antenna

The following section will illustrate two scenarios in which Duro antennas can be mounted and deployed.

### With Top-Mounted GNSS Antenna



Duro comes with a top-mounting GNSS antenna bracket that is easy to install. The following images describe the installation steps, measurements and technical names for the mounting parts.

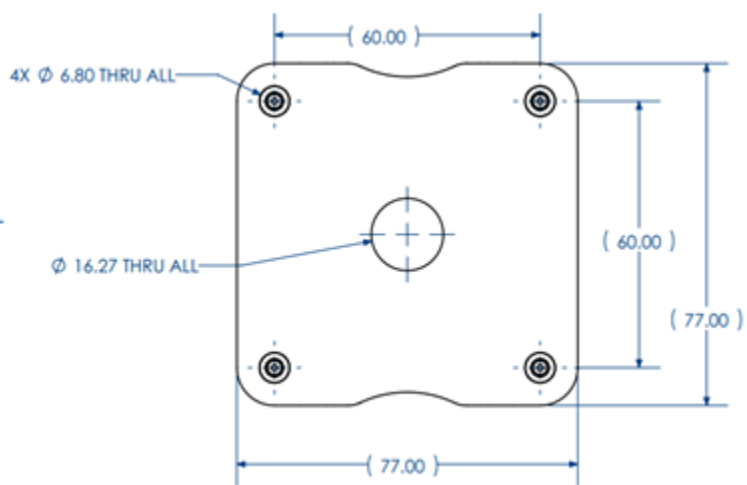
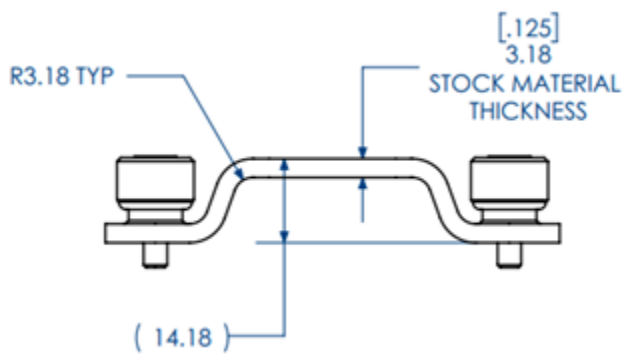

1. The following kit parts are required for GNSS antenna mounting on the top of Duro:

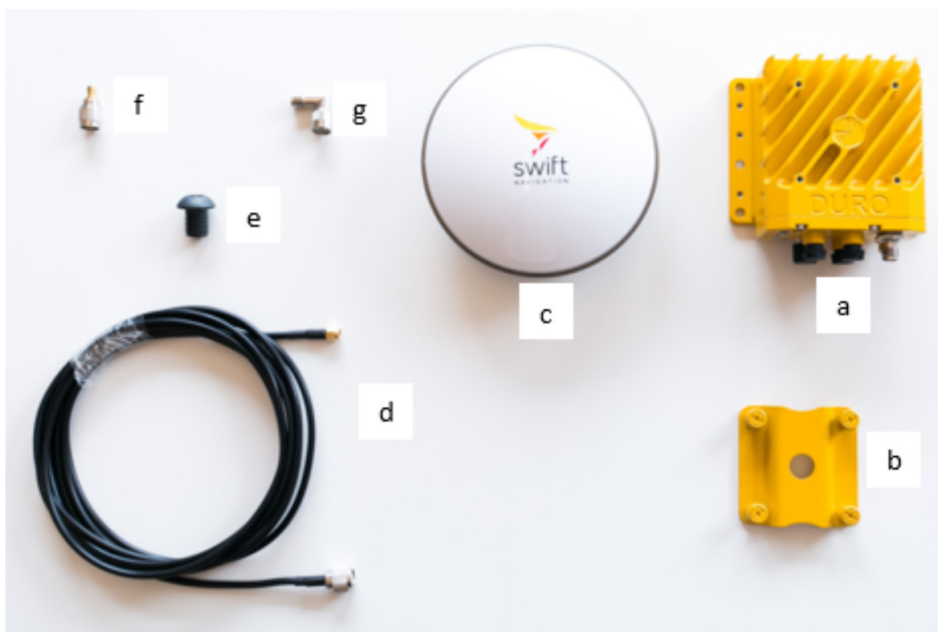

- a. Duro
- b. Top Mounting Base
- c. GNSS Antenna
- d. GNSS Cable
- e. Mounting Screw
- f. TNC-M to SMA-F Adapter
- g. TNC L Adapter

2. Proceed to put together the GNSS antenna with the mounting base.

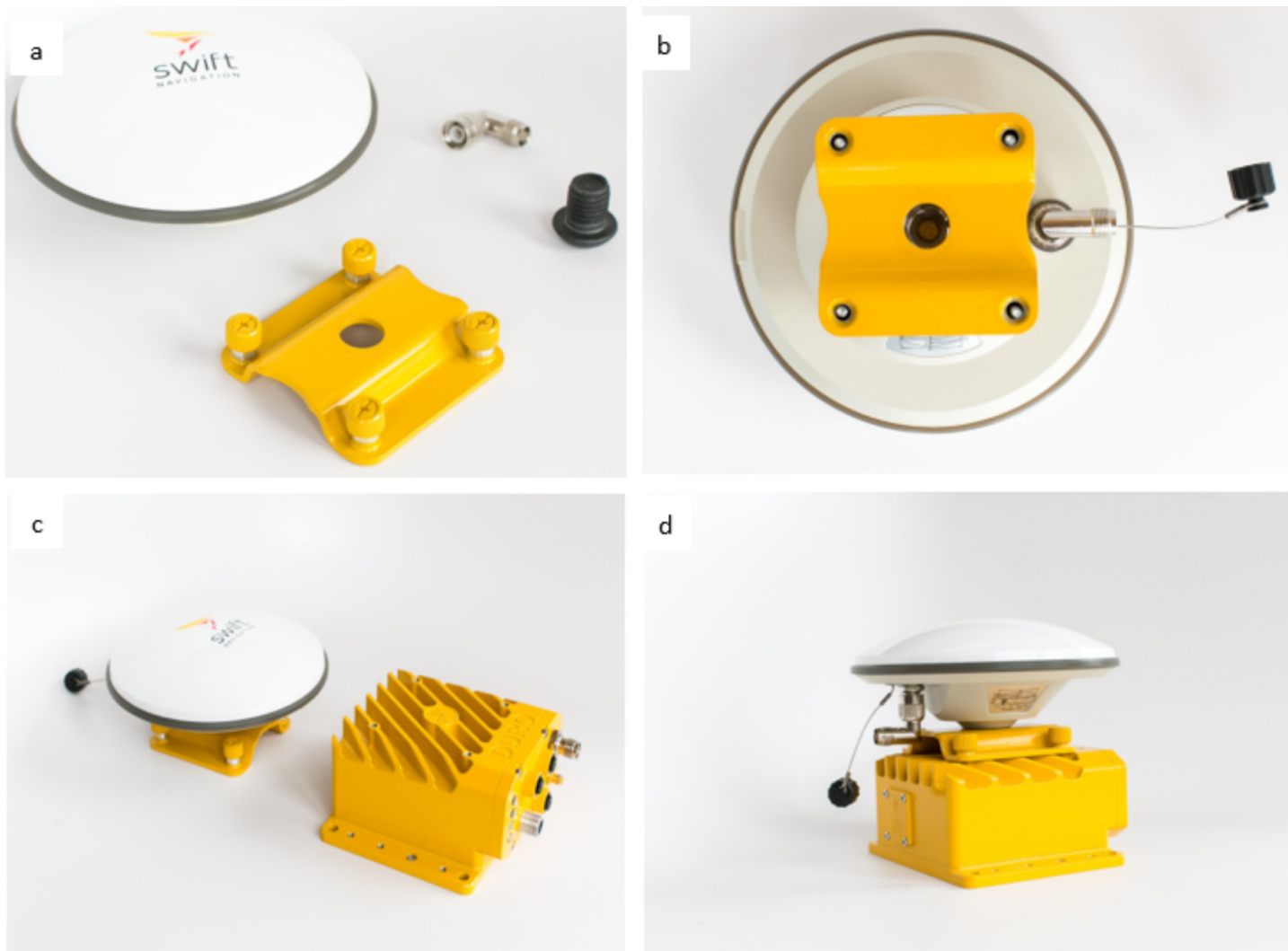

#### Attach Antenna to Bracket

- a. Obtain GNSS antenna,  $\frac{5}{8}$ " x 11 screw and antenna bracket.
- b. Thread black  $\frac{5}{8}$  x 11 screw into antenna through mounting bracket.
- c. Thread right angle TNC adapter onto antenna.
- d. Mount antenna bracket on Duro with thumb screws.

3. Connect the TNC-M to SMA-F Adapter to Duro and then the GNSS antenna cable.

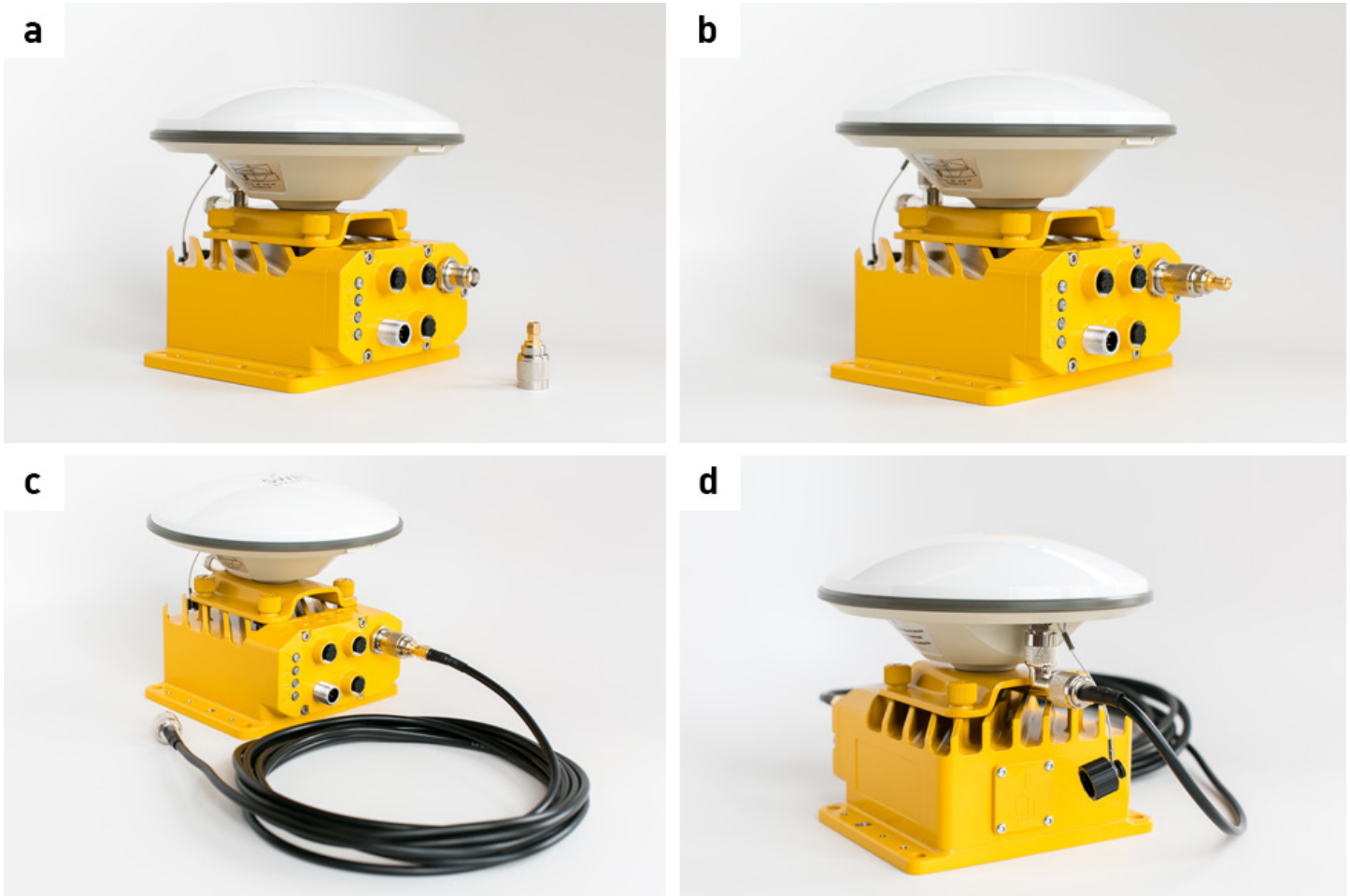

#### Connect Antenna to Duro

- a. Obtain TNC-SMA adapter and antenna coaxial cable.
- b. Attach TNC-SMA adapter to Duro.
- c. Attach SMA side of coaxial cable to Duro.
- d. Attach TNC side of coaxial cable to antenna. Stow excess antenna cable.

#### Large GNSS Antenna Cable

Duro comes with a 36-inch GNSS antenna cable allowing connection of the antenna away from the Duro.

#### Grounding Duro

We highly recommend grounding of the chassis either at the m4 screw or through the chassis pin in the power cable. Grounding of the chassis is required to ensure safety and RF performance.

## Power

The following section presents the minimum and maximum power range for Duro. This section is subdivided into "Input" and "Output" sections, to make clear from where to obtain or provide energy. Duro requires a minimum of 5 watts of power for its own operation. When powering Duro, ensure the power supply can meet Duro's power requirements plus the power requirements for any downstream devices powered by Duro's outputs.

Input	Range
Input Voltage Range	12 V to 24V

Output	
AUX Connector	5 V - 0.25 Amps: 1.25 W 12 V - 1 Amp: 12 W
Serial Connector	12 V - 1 Amp: 12 W

<sup>1</sup> The recommended voltage is 12 to 24 volts. A minimum of 10 volts can be applied. At 10 Volts Swift Navigation cannot guarantee that the output voltage will be met for other interfaces or applications. 35 Volts is the absolute maximum that can be applied to Duro.

## Interfaces

### LED Indicators

The LEDs are located in the front left side of Duro. The operation mode is described in the table below.

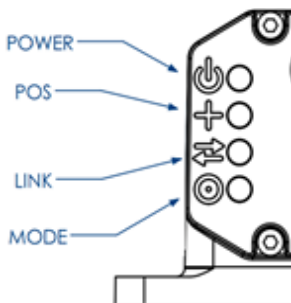

Led Description			
LED Name	Color	State	Description
<b>POWER</b>	LED Off	Off	No power
	Green	Continuously On	Module receiving power
	LED Off	Off	No solution, antenna not detected, no GNSS signal received
<b>POS</b>	Yellow	Slow Blink	No solution, antenna detected, no GNSS signal received
	Yellow	Fast Blink	No solution, GNSS signal received
	Yellow	Continuously On	GNSS solution available (any kind)
<b>LINK</b>	LED Off	Off	No incoming corrections or Internet access
	Red	Flashing	Incoming corrections, no Internet access
	Red	Continuously On	No incoming corrections, Internet access
	Red	Continuously On and Flashing (Occulting)	Internet access and incoming corrections
<b>MODE</b>	LED Off	Off	No RTK
	Blue	Blinking	Float RTK mode
	Blue	Continuously On	Fixed RTK mode

## Serial Ports

Duro comes with two serial ports, UART0 and UART1 respectively, that operate at RS-232 levels. UART1 is ready to be used by connecting the serial-USB cable from a computer to the AUX port cable (provided in the Duro Evaluation Kit).

<b>Default Baud Rate</b>	<b>115200</b>
--------------------------	---------------

By default, UART0 only sends SBP RTK corrections information if Duro is configured as the base station. Enable UART0 for use with the Swift Console or other software through the settings interface by removing the message whitelist for the UART.

## AUX

Both Serial Ports can be configured for different protocols, baud rates and with or without hardware flow control.

The Auxiliary Port provides connection to Duro through UART1 and CAN1 interfaces.

## GNSS Tracking

Duro currently supports dual frequency GPS/GLONASS/BEIDOU/GALILEO signals as seen below.<sup>2</sup>

Constellation	Signal Bands
GPS	L1 / L2C
GLONASS	G1 / G2
BEIDOU	B1 / B2
GALILEO	E1 / E5b

<sup>2</sup> Piksi Multi FW 2.0 will support raw GNSS Data Observations (GPS L1/L2+GLO G1/G2+ BEIDOU B1/B2+GALILEO E1/E5b) up to 10 Hz or 10 Hz RT solution output. However, to get all 4 constellations simultaneously, the baud rate required is 230400.



## Accuracy

Position, Velocity and Time Accuracy		
Horizontal Position Accuracy (CEP 50 in SPP Mode)		2.5 m
Velocity Accuracy		0.03 m/s RMS
Time Accuracy		60 ns RMS
Real Time Kinematic (RTK Accuracy $1\sigma$ )	Horizontal	0.010 m + 1 ppm
	Vertical	0.015 m + 1 ppm
RTK Initialization Parameters	Initialization Time	< 10 s
	Initialization Reliability	>99%
	Solution Latency	<30 ms
Time to First Fix (TTFF)	Hot Start	< 7 s
	Cold Start	< 60 s
	Reacquisition	<2 s

# Connecting to Duro

## Ethernet Connection

### Swift Console

1. Proceed to connect the Ethernet Cable from your computer to Duro. Set up a local IP as shown below:

IP Address: 192.168.0.10

Subnet Mask: 255.255.255.0

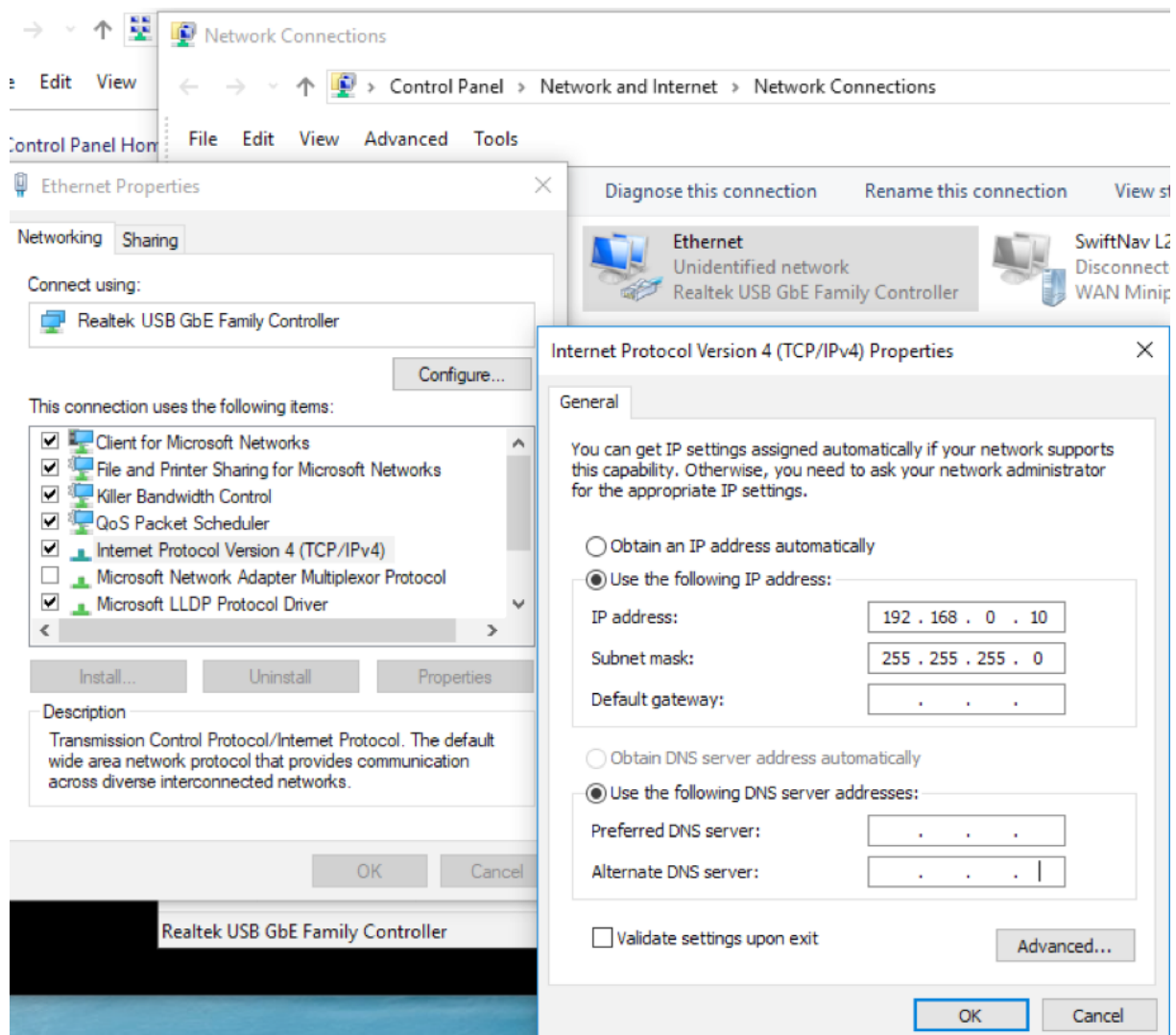

2. Ensure you can reach Duro from your computer. The default Duro IP Address is 192.168.0.222.

```
C:\Windows\System32\cmd.exe
Microsoft Windows [Version 10.0.15063]
(c) 2017 Microsoft Corporation. All rights reserved.

C:\Windows\System32>ping 192.168.0.222

Pinging 192.168.0.222 with 32 bytes of data:
Reply from 192.168.0.222: bytes=32 time<1ms TTL=64
Reply from 192.168.0.222: bytes=32 time<1ms TTL=64
Reply from 192.168.0.222: bytes=32 time<1ms TTL=64
Reply from 192.168.0.222: bytes=32 time<1ms TTL=64

Ping statistics for 192.168.0.222:
    Packets: Sent = 4, Received = 4, Lost = 0 (0% loss),
    Approximate round trip times in milli-seconds:
        Minimum = 0ms, Maximum = 0ms, Average = 0ms

C:\Windows\System32>
```

3. On your desktop, create a new shortcut:

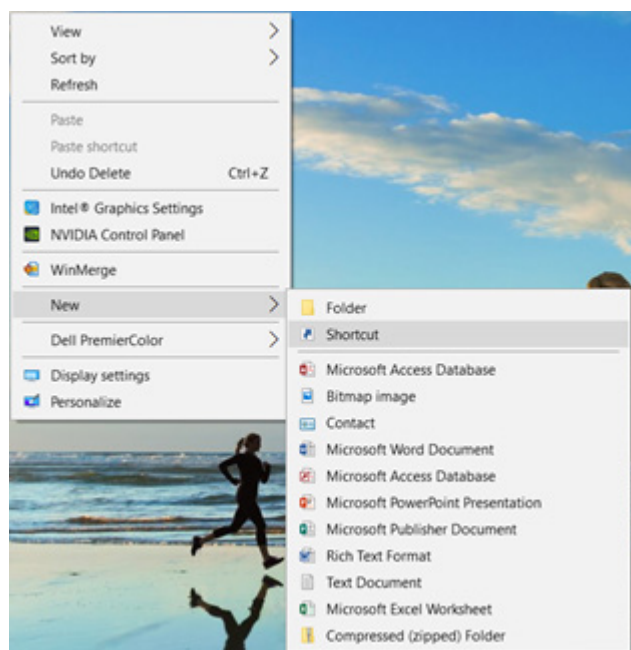

4. In the Create Shortcut window, proceed to paste the directory as specified below:

`"C:\Program Files (x86)\Swift Navigation\Swift Console\console.exe"`

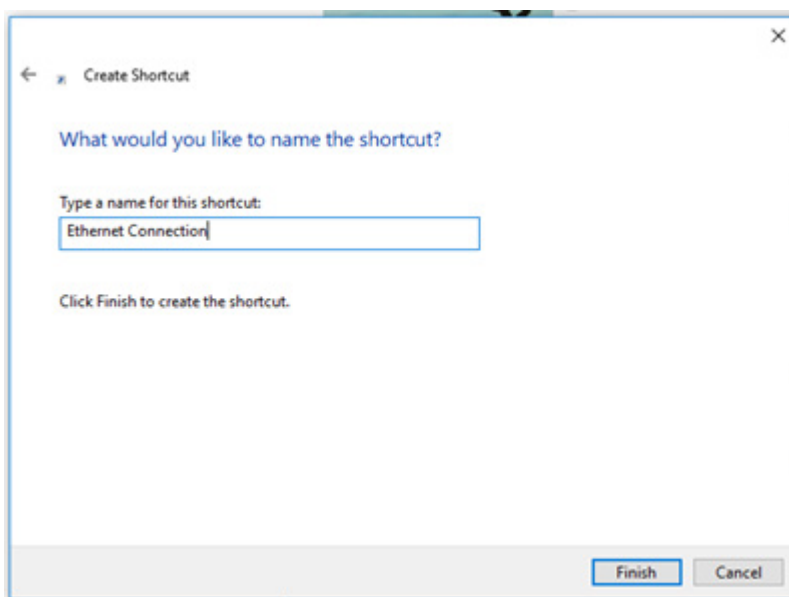
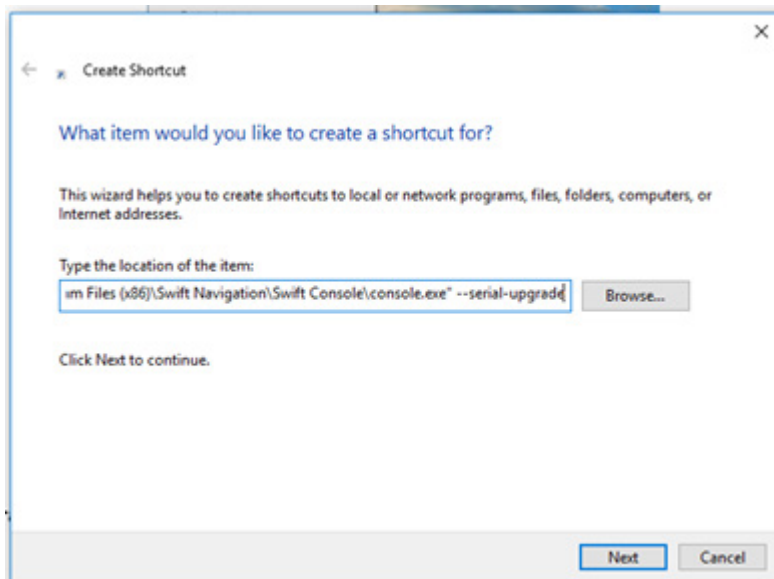

- Click on the recently-created shortcut. The Swift Console Connection Interface will pop up. Proceed to select TCP/IP and then click "OK".

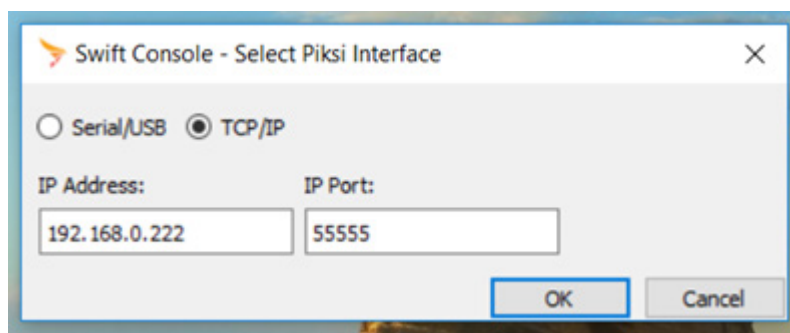

- It can take up to 90 seconds to acquire a signal(s). The "Tracking" Tab confirms the signals Duro has acquired:



## Serial Connection

Duro comes with two Serial ports, one enabled by default (UART1) and the other one requires configuration to be used (UART0).

Proceed to connect the Serial-USB adapter between your computer and Duro. Ensure this connection is being made through the Serial port 1, located in the Auxiliary port (Duro AUX cable recommended).

# Firmware Upgrades

## Swift Console

Please proceed to execute the following steps:

1. You should be able to see information in the Swift Navigation Console Tracking tab:

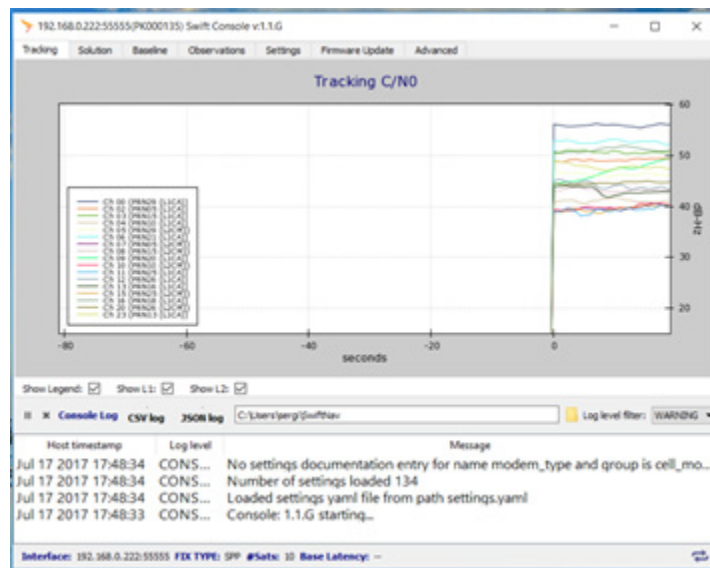

2. Go to the Firmware Upgrade tab, Select the Binary File to be uploaded into Piksi Multi and click Upgrade FW.

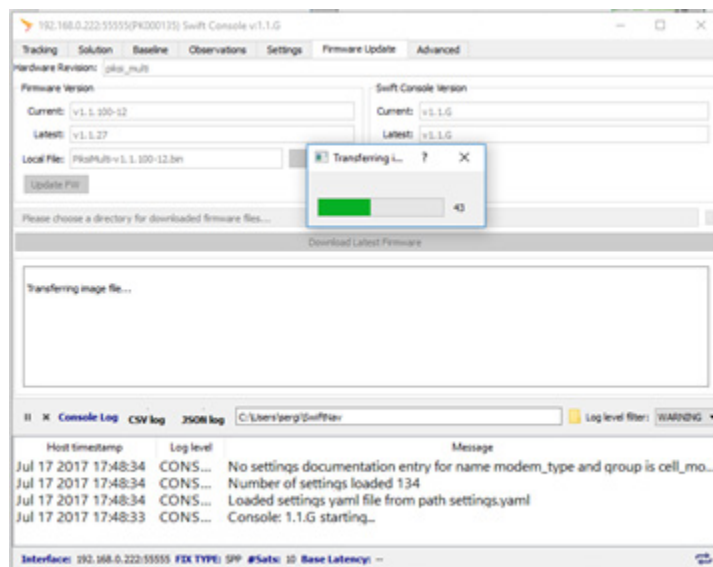

- An "Upgrade Completed" message will be shown and your Duro will restart. Then close your Swift Console.

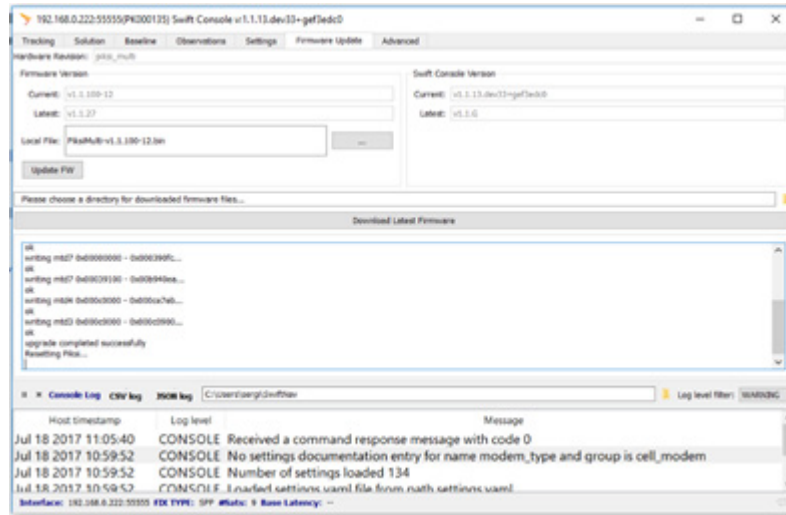

- Connect again to the Swift Console and go to the Firmware Update tab. Verify the firmware version.

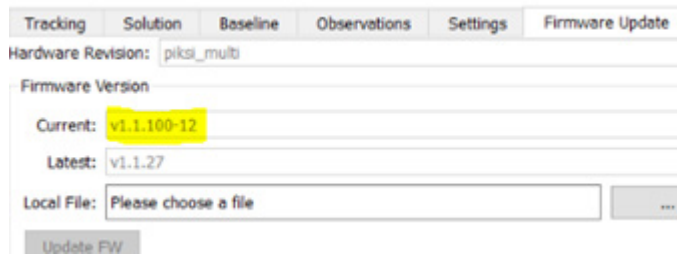



# Swift Navigation Technical Support

## Support Site

Further Swift product support information is available at [support.swiftnav.com](http://support.swiftnav.com). The support site also allows Duro users to get in touch with Swift technical support and to ask public questions to the community.

Specifically, the following support documents are useful for integration support of Duro.

Additional Support documentation	
Name	Description
<a href="#">Swift Binary Protocol (SBP)</a>	Support information for Duro and Piksi Multi native on-the-wire communication protocol.
<a href="#">Firmware Settings Manual</a>	Information about all of the configuration options exposed for Duro's firmware.

## Supporting Tools

Additional Support Tools	
Name	Description
<a href="#">Swift Console</a>	Support information and download of the Swift Console, the Graphical User Interface (GUI) for test and evaluation of Duro.
<a href="#">SBP2Rinex</a>	Cross platform command line utility for converting raw SBP log information to the Receiver Independent Exchange format (Rinex).

## Contact Us

Swift Navigation, Inc.  
 650 Townsend Street, Suite 410  
 San Francisco, CA 94103  
[swiftnav.com/contact-us](http://swiftnav.com/contact-us)